

BUCKLING OF DRILL STRING UNDER THE ACTION OF GRAVITY AND AXIAL THRUST

X. C. TAN and P. J. DIGBY

Department of Mining and Underground Construction, Luleå University of Technology,
S-95187, Luleå, Sweden

(Received 11 May 1992; in revised form 1 March 1993)

Abstract—A number of different equilibrium helical buckling configurations for a tubing or drill string confined within a cylindrical casing or hole of larger radius and buckled under static compressive forces are determined. Our work is more general and informative than earlier work since the solutions relating the buckling load and the postbuckling configuration are given explicitly for the string of weight and at any inclined positions. A consideration of the state of transient string buckling when the string undergoes sudden change in the helix radius and might lose contact with the hole wall is also proposed.

1. INTRODUCTION

Whenever applied or gravity-induced compressive forces reach some critical magnitude, a long and slender tubing or drill string radially confined in a cylindrical hole will be buckled. The postbuckling of a tubing–drill string in a cylindrical hole (or casing) is of significant importance to the tubing design and drilling operation in petroleum and other drilling industries. The buckled configuration of the tubing or drill string will have serious consequence for the life of the tubing or drill pipes, the rock breakage as well as the resulting hole trajectory. The relations of sufficiently general analysis of the buckling of the strings will therefore lead to an understanding of methods by which the difficulties encountered in drilling and production operations described above may be reduced. Due to this long standing general interest, a number of researchers have presented their work on the behaviour of the buckled tubing and drill string. The investigation of the helical buckling of a tubing string subjected to an applied compressive force was first conducted by Lubinski *et al.* (1962). Since then, a number of authors [see for instance, Paslay and Bogy (1964), Dawson and Paslay (1984), Cheatham and Pattilo (1984), Mitchell (1988) and Kwon (1988)], have attempted to analyse the string buckling by different approaches and in a more accurate way.

The deformation of the buckling configuration of a tubing–drill string under applied axial loads is a stability problem. Lubinski and Cheatham treated the drill–tubing string as a weightless helix in contact with the hole wall along its entire length. The relationship between the applied axial forces and the pitch of the helix for the string in its buckled configuration were obtained. These results are applicable to a weightless string of infinite length. String weight has a significant effect on the buckling. It is common practice that the strings are compressed only in the lower sections and buckle under their own weight. Paslay and Bogy (1964) included the string weight in their work and assumed that the buckled string took the shape of a Fourier function. The string remained in contact with the hole wall along its entire length and throughout the deformation–buckling process. However, no quantitative solution was arrived at for the configuration of a buckled string. Applying the slender beam theory, Mitchell (1988) and Kwon (1988) extended Lubinski's helical buckling model by assuming a varying helical pitch for strings with weight. However, the explicit solution could be obtained only in vertical holes, which took a similar form to Lubinski's with the buckling force term as a variable. Their emphasis was placed on the study of the string buckling below the neutral point above which the string was subjected to tensile loads.

In the present paper, we present the explicit solutions to the helically buckled string in any inclination angle. The string is subjected to both a concentrated axial force at one end

and gravitational distributed forces along the entire string. The behaviour of drill-tubing strings under static compressive loads is under consideration here. However, we show in our model, that under appropriate increasingly applied static compressive loads, a buckled string can assume a number of discrete stable equilibrium configurations (modes) in each of which the drill string will be buckled into a helix of definite pitch. In suddenly passing from one buckled mode to the next, we also suppose that the string undergoes a process of so-called (unstable) "transition buckling", in which a portion of the drill string may instantaneously lose contact with the hole wall. Critical buckling loads, in terms of helix pitch, string stiffness and weight, hole clearance and inclination, and applied axial loads obtained from our model in a number of special cases are also compared with those from Lubinski *et al.* (1962), Dellinger *et al.* (1983), Dawson and Paslay (1984), Mitchell (1988) and Gere and Timoshenko (1990).

2. CONFIGURATION GEOMETRY FOR A BUCKLED STRING

A drill string is slender. For instance, a 6 3/4-in-diameter drill string can be over 1000 ft in length and is confined in a 8 3/4-in-diameter hole. A similar situation is also seen for the tubing string, which is employed after the accomplishment of the oil well. Under the action of the applied axial force and gravity forces (the weight of the string), the long and slender string will buckle in the narrow space bounded by the surrounding hole wall (a circular cylinder). It is assumed that when the drill string buckles and is in a state of stable equilibrium, its configuration will be defined by a helix (corresponding to the buckled drill string axis). The geometry of the helix is shown in Fig. 1(a). A "half-wave" of the helix (whose radius r is equal to the difference between the hole radius and the string radius), is generated by wrapping the triangle ABC [Fig. 1(b)] around the cylinder surface of radius r in Fig. 1(a). Then, t defines the "pitch" corresponding to one half-wave length of the helix. We then have the following parametric equations defining the helix shown in Fig. 1(a)

$$\begin{aligned}x &= r \cos \gamma \\y &= r \sin \gamma \\z &= \frac{t}{\pi} \gamma\end{aligned}\quad (1)$$

where x , y , z are the coordinates of a representative point on the helix and γ is the angular coordinate.

Also from Fig. 1, the helix raising angle is given by

$$\sin \phi = \frac{t}{\sqrt{t^2 + \pi^2 r^2}}. \quad (2)$$

If L is the total helical string length and n the number of half-waves (mode number) into which the string is assumed to buckle, we then have

$$L = n\sqrt{t^2 + \pi^2 r^2} \approx nt \quad (3)$$

and

$$\gamma = n\pi. \quad (4)$$

In Fig. 1(a), the hole axis is the z -axis and inclined at an angle α to the vertical. The x -axis is so chosen that the x - z plane is a vertical plane.

From equation (A7) in the Appendix, we have for radius of curvature R of the helix as follows

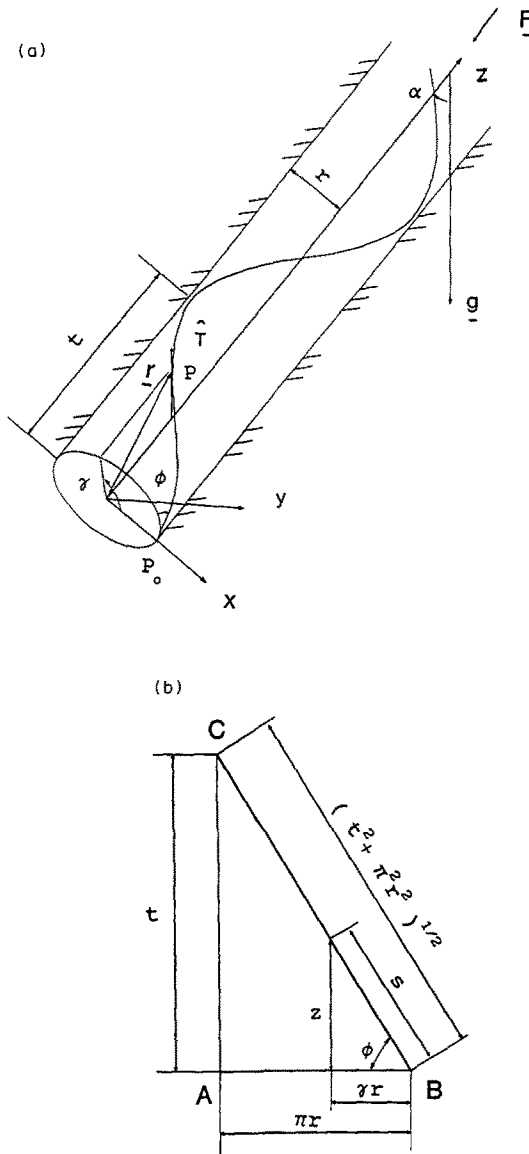

Fig. 1. The configuration of helically buckled drill (tubing) string. (a) The helix string confined in a cylindrical hole. (b) The helix half-wave expanded in a plane.

$$R = r \sec^2 \phi = \frac{t^2 + \pi^2 r^2}{\pi^2 r} \approx \frac{t^2}{\pi^2 r}. \tag{5}$$

3. THE TOTAL ENERGY OF THE SYSTEM

In this work it is supposed that we have a conservative mechanical system. In particular, for example, the effect of frictional forces between the string and the hole wall are ignored and, under the action of external forces the string undergoes purely elastic (recoverable) deformations. The equilibrium of the buckled string can then be discussed by considering the conditions under which the total energy of the system (composed only of the strain energy in the buckled string and the potential energy of the forces acting on the string) will assume a relative minimum (Langhaar, 1962).

3.1. Strain energy in the buckled string

Since the string is constrained by the hole wall, it undergoes small deflections and so the torque generated due to the curvature of the string as it buckles into a helix is ignored

[see Landau and Lifshitz (1970)] and the strain energy stored in the string, U_t due to couples tending to twist the drill string about its axis (in torsion) is negligible. Also the strain energy, U_c stored in the string due to compressive forces acting on the string undergoes little change compared with the strain energy, U_b stored in the string due to bending moments acting on the string and U_c can therefore be assumed to be constant. The curvature of the string in its buckled helical configuration is constant [see eqn (5)]. From eqn (A11) the strain energy stored in the string in its deformed configuration due to bending moments acting on it may therefore finally be written in the form

$$U_b = \frac{EIL_c}{2R^2} \approx \frac{\pi^4 EILr^2}{2l^4}. \quad (6)$$

In eqn (6), E is the Young's modulus of the string, and I its radius of gyration, both assumed constant. L and L_c are the lengths of the string before and after compression.

3.2. Potential energy of the external strings

When the string deforms and is in a state of static equilibrium, we suppose that its configuration is defined by a helix. As in Section 2 (see also Fig. 1), we suppose that s denotes the arc length on the helix measured from the bottom P_0 of the string to the representative point $P(x, y, z)$ on the helix. $\Delta L(s)$ and $\varepsilon(s)$ denote the component of displacement (tangential to the string) and tensile strain in the string respectively, measured at the point P .

The force acting on the helix at the point P is composed of the weight of the section of the string above P and the applied thrust F at the upper end of the string. The total force acting on the helix at the point P [see Fig. 1(a)] is therefore given by

$$\mathbf{F}_T = q(L-s) \sin \alpha \mathbf{i}_\nu - [F + q(L-s) \cos \alpha] \mathbf{i}_z \quad (7)$$

where q denotes the weight of a unit length of the string. The component of this force in the direction tangential to the local string axis at P [see eqns (A2)] is therefore given by

$$\begin{aligned} F_\Sigma(s) &= \hat{\mathbf{T}} \cdot \mathbf{F}_T \\ &= -q(L-s) \cos \phi \sin \gamma \sin \alpha - q(L-s) \sin \phi \sin \alpha - F \sin \phi. \end{aligned} \quad (8)$$

The compressive strain $\varepsilon(s)$ at the point P on the helix due to the forces $F_\Sigma(s)$ is given by

$$\varepsilon(s) = \frac{F_\Sigma(s)}{EA} \quad (9)$$

and the displacement of the point P to the helix is therefore

$$\begin{aligned} \Delta L(s) &= \int_0^s \varepsilon(s) \, ds \\ &= -\frac{1}{EA} [qr \sin \alpha (t/\pi - s \cos \gamma) + Fs \sin \phi + \frac{1}{2}qs^2 \cos \alpha \sin \phi] \end{aligned} \quad (10)$$

from which, the displacement of the top end is

$$\Delta L(L) = \int_0^L \varepsilon(s) \, ds = -\frac{1}{EA} [qrL \sin \alpha + FL \sin \phi + \frac{1}{2}qL^2 \cos \alpha \sin \phi]. \quad (11)$$

The potential energy of the externally applied force F is therefore

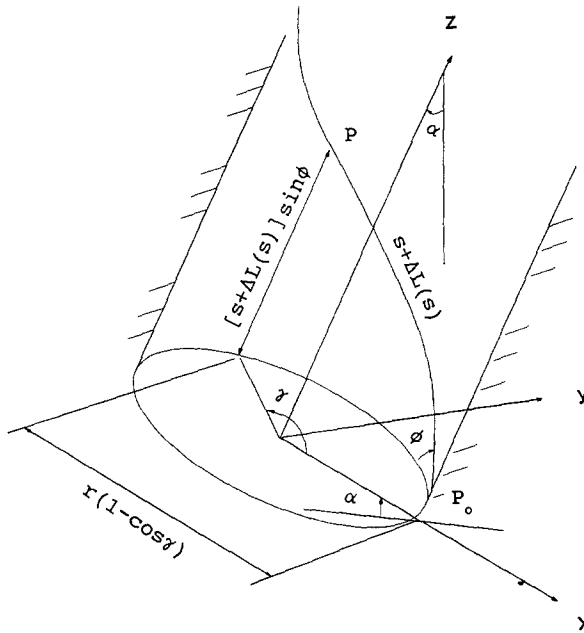

Fig. 2. Potential of the helix drill string.

$$\begin{aligned}
 U_{pF} &= F \sin \phi (L + \Delta L(L)) \\
 &= FL \sin \phi \left(1 - \frac{F \sin \phi}{EA} - \frac{qL \cos \alpha \sin \phi}{2EA} + \frac{qr \sin \alpha}{EA} \right) \\
 &\approx FL \sin \phi
 \end{aligned} \tag{12}$$

where in the above we have supposed that the dimensionless terms F/EA , qL/EA , qr/EA and qt/EA are all much smaller than unity.

The potential energy of the forces acting on the string due to its own weight are obtained by integrating the potential energy due to the weight of a small length of the string, ds . Thus the potential energy of the string due to its own weight (see Fig. 2) is obtained as

$$\begin{aligned}
 U_{pq} &= \int_0^L (s + \Delta L(s)) \cos \alpha \sin \phi q \, ds + \int_0^L qr \sin \alpha (1 - \cos \gamma) \, ds \\
 &= \frac{1}{2} qL^2 \cos \alpha \sin \phi \left(1 - \frac{F \sin \phi}{EA} - \frac{qL \cos \alpha \sin \phi}{3EA} \right) \\
 &\quad + qLr \sin \alpha - \frac{q^2 Ltr}{\pi EA} \sin \alpha \cos \alpha \sin \phi \\
 &\approx \frac{1}{2} qL^2 \cos \alpha \sin \phi + qLr \sin \alpha.
 \end{aligned} \tag{13}$$

In the above equation, we have again supposed that the dimensionless terms F/EA , qL/EA , qr/EA and qt/EA are all much smaller than unity.

3.3. The total energy of the system

The total energy of the system will be equal to the sum of the strain energy stored in the string and the potential energy of the external forces acting on the system.

From eqns (6)–(13) above, the total energy of the system will be

$$\begin{aligned}
 V &= U_b + U_c + U_t + U_{pF} + U_{pq} \\
 &\approx \frac{\pi^4 EILr^2}{2t^4} + FL \sin \phi + \frac{1}{2}qL^2 \cos \alpha \sin \phi + qLr \sin \alpha + U_c \\
 &\approx \frac{\pi^4 EILr^2}{2t^4} - \frac{\pi^2 r^2 L}{2t^2} (F + \frac{1}{2}qL \cos \alpha) + qLr \sin \alpha \\
 &\quad + FL + \frac{1}{2}qL^2 \cos \alpha + U_c
 \end{aligned} \tag{14}$$

where, from eqn (2), $\sin \phi \approx 1 - (\pi^2 r^2 / 2t^2)$ since $(r/t) \ll 1$.

4. CRITERIA OF EQUILIBRIUM AND STABILITY FOR THE STRING

4.1. Criteria of equilibrium

A necessary and sufficient condition for the string to be in a state of equilibrium in its deformed configuration [a helix of pitch t and radius r , see eqns (1)] is that the first order variation δV of the total energy of the system given by eqn (14) be zero for arbitrary variations δt and δr . From eqn (14) the condition for the system to be in equilibrium is therefore

$$\begin{aligned}
 \delta V &= \frac{\partial V}{\partial t} \delta t + \frac{\partial V}{\partial r} \delta r \\
 &= \delta r \frac{\pi^2 Lr}{t^2} \left[\frac{EI\pi^2}{t^2} - (F + \frac{1}{2}qL \cos \alpha) + \frac{qt^2 \sin \alpha}{\pi r^2} \right] \\
 &\quad - \delta t \frac{\pi^2 Lr^2}{t^2} \left[\frac{2EI\pi^2}{t^2} - (F + \frac{1}{2}qL \cos \alpha) \right] \\
 &= 0.
 \end{aligned} \tag{15}$$

To obtain explicit criteria for equilibrium and stability, let us consider the variation in t and r respectively.

First consider the case in which the helix radius is maintained constant, that is, $\delta r = 0$ but $\delta t \neq 0$. The equilibrium criteria expressed as the relation between the critical buckling loads F , g and the helix pitch t , will be, from eqns (15) and (3),

$$F + \frac{1}{2}qL \cos \alpha = \frac{2EI\pi^2}{t^2} = \frac{2EI\pi^2 n^2}{L^2}. \tag{16}$$

For convenience, we define the function

$$P = F + \frac{1}{2}qL \cos \alpha \tag{17}$$

and eqn (16) can then be written in the form

$$P = \frac{2EI\pi^2}{t^2}. \tag{18}$$

Consider then the case in which the helix pitch is maintained constant, that is, $\delta t = 0$ but $\delta r \neq 0$, we have, by substituting eqns (3) and (17) into (15)

$$\begin{aligned}
 P &= \frac{EI\pi^2}{t^2} + \frac{qt^2 \sin \alpha}{\pi r^2} \\
 &= \pi^2 EI \left(\frac{n}{L}\right)^2 + \frac{q \sin \alpha}{\pi^2 r} \left(\frac{L}{n}\right)^2.
 \end{aligned} \tag{19}$$

Letting dP/dt in eqn (19) equate to zero, we obtain the minimum load

$$P_0 = 2 \left(\frac{EIq \sin \alpha}{r} \right)^{1/2} = \frac{2EI\pi^2}{t_0^2} \tag{20}$$

corresponding to the pitch

$$t_0 = \pi \left(\frac{EIr}{q \sin \alpha} \right)^{1/4}. \tag{21}$$

4.2. Stability criteria

The necessary and sufficient condition for the string to be in a state of stable equilibrium in its deformed configuration is that the second order variation $\delta^2 V$ of the total energy of the system given by eqn (14) is always positive, that is

$$\delta^2 V = \frac{\partial^2 V}{\partial t^2} \delta t^2 + 2 \frac{\partial^2 V}{\partial t \partial r} \delta t \delta r + \frac{\partial^2 V}{\partial r^2} \delta r^2 > 0 \tag{22}$$

for arbitrary variations in δr and δt . However, we will obtain the criteria of stability for the cases either $\delta t \neq 0$ and $\delta r = 0$ or $\delta r \neq 0$ and $\delta t = 0$, so that we can examine the stability of the corresponding equilibrium states [eqns (16) and (19)] obtained in Section 4.1.

From inequality (22), the stability criterion for the case in which the helix radius is maintained constant, $\delta r = 0$, but $\delta t \neq 0$ is given by

$$F + \frac{1}{2}qL \cos \alpha < \frac{10EI\pi^2}{3t^2}$$

or

$$P < \frac{10EI\pi^2}{3t^2}. \tag{23}$$

Similarly, the stability criterion for the case in which the helix pitch is maintained constant, $\delta t = 0$, but $\delta r \neq 0$ is given by

$$F + \frac{1}{2}qL \cos \alpha < \frac{EI\pi^2}{t^2}$$

or

$$P < \frac{EI\pi^2}{t^2}. \tag{24}$$

5. DESCRIPTION OF THE STRING EQUILIBRIUM STATES

The conditions for the string equilibrium in its postbuckling condition [eqns (16) and (19)] together with the corresponding conditions for stable equilibrium [inequalities (23) and (24) respectively], for the cases $\delta r = 0$, $\delta t \neq 0$ and $\delta t = 0$, $\delta r \neq 0$ respectively will now be discussed below.

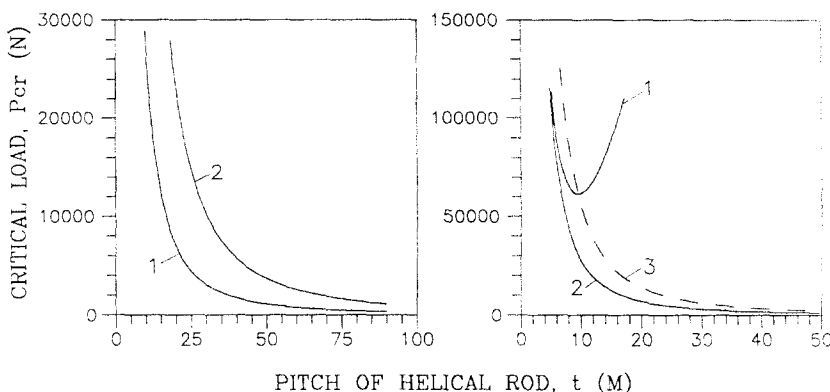

Fig. 3. Criteria of equilibrium and stability. (a) Continuous buckling; (b) transition buckling.

5.1. *Equilibrium of the string for the case in which the buckled string has constant helix radius, that is, $\delta r = 0$, but $\delta t \neq 0$*

It is supposed here that the drill string is deformed into a helix whose radius remains constant. In this case, the string remains in contact with the drill hole wall along its entire length, throughout the process of deformation and buckling as the symbolic load variable P [eqn (17)] varies. The equations of equilibrium which relate P to t [eqn (18)] are plotted in Fig. 3(a) [curve (1)] and the corresponding stability criterion [inequality (23)] is represented in the same figure as the area below curve (2). Here, it can be seen that the equilibrium curve lies completely inside the region for stable equilibrium of the string. Any equilibrium configuration of the string where it is initially in contact with the drill hole wall and in which contact is maintained ($\delta r = 0$) will be one of stable equilibrium, where the drill string deforms into a helix whose radius r remains constant, but whose pitch t varies continuously with the load P [eqn (18)].

5.2. *Equilibrium of the buckled string for the case in which the helix pitch is maintained constant, that is $\delta t = 0$, but $\delta r \neq 0$*

We suppose here that any change in the helix radius, where the drill string loses contact with the drill hole wall, would have occurred over a very small interval of time ("instantaneously"). The actual equilibrium load P [equation (19) in this case] is plotted as a function of the helix pitch t [curve (1) in Fig. 3(b)]. Here, it can be seen that the curve (1) lies completely outside the region bounded by curve (2) [inequality (24)] defining the configurations for stable equilibrium of the string. Any equilibrium configuration of the drill string for which contact with the drill hole wall has been initially lost, and in which the helix radius is allowed to vary ($\delta r \neq 0$) will therefore be one of unstable equilibrium. In this case it appears reasonable to suppose that in regaining contact with the drill hole wall, the drill string geometry will undergo a discontinuous (finite) change in passing from one stable equilibrium configuration to another.

5.3. *Relations between different equilibrium states of the string*

Curve (3) in Fig. 3(b) corresponds to the equilibrium configuration for the continuous buckling process [eqn (18)]. It intersects the equilibrium curve (1) for the transition buckling [eqn (19)] for the case of non-vertical holes at the point (t_0, P_0) [see eqns (20) and (21)]. The distinct stages in the buckling of the string may therefore be defined from the boundary point (t_0, P_0) , if we assume that the string will buckle at the smallest critical load. The string buckling will thus take place in a form of either the continuous buckling or the transition buckling. Assume that the buckling load is applied gradually, the string will undergo "continuous buckling" in the initial stage when $P < P_0$. Here, the drill string is initially in contact with the drill hole wall and the helix radius r is maintained constant ($\delta r = 0$). In this case, we have stable equilibrium and the drill string has deformed into a helix whose pitch t varies ($\delta t \neq 0$) continuously with the load P . So long as contact of the drill string with the drill hole wall is maintained, the "buckling mode" number (n), that is, the number

of half-waves of helix into which the string is deformed [eqn (3)] will also be changed continuously as the load P is varied. Once the load P reaches the critical value P_0 [eqn (20)], a transitional stage in buckling will occur where in resuming contact with the hole wall, the helically buckled string will undergo a discontinuous (finite) change in passing from one stable equilibrium configuration to another. Here, a sudden (finite) jump in the buckling mode number n will occur. During this process, the string has instantaneously lost contact with the drill hole wall.

It can be observed that transition buckling [curve (1) in Fig. 3(b)] usually occurs at rather large buckling loads (for non-vertical holes) and continuous buckling is more likely to occur when the load is relatively small.

6. PARAMETRIC ANALYSIS OF HELICAL BUCKLING

The effects of the general variables on the string buckling configuration are to be examined individually below.

6.1. Effect of buckling force

Buckling forces determine directly the string buckling. The relationship between the buckling load P and the helix pitch t can be clearly observed from eqns (16) and (19), which are shown schematically in Fig. 3(a) and (b) (curve 2). The effect of buckling load on the form of buckling and the postbuckling configuration has been described in detail in Section 5.

6.2. Effect of hole inclination

The critical load P_{cr} for transition buckling [eqn (19)] is plotted as a function of the helix pitch t for different drill hole inclinations to the vertical in Fig. 4. In these plots, the numerical values of the other parameters in eqn (19) are

$$EI = 2.8 \times 10^5 \text{ N m}^{-2} \quad r = 0.02 \text{ m}$$

$$q = 197 \text{ N m}^{-1} \quad \nu = 0.3.$$

It can be seen from this figure that for any given pitch t , the horizontal string ($\alpha = 90^\circ$) has the largest buckling load. For a vertical string ($\alpha = 0^\circ$), the last term in eqn (19) vanishes and this plot corresponds to that from eqn (24) which defines the boundary of the region for stable equilibrium in transition buckling. So for holes near vertical, the load given by eqn (19) is always less than that by eqn (16). In this case, t_0 approaches infinite [eqn (18)] and P_0 is close to zero. So transition buckling will seemingly dominate the whole buckling process for any buckling load $P > 0$. For the remaining hole inclinations ($\alpha \neq 0^\circ$), the corresponding minimum critical loads P_0 for transition buckling [eqn (20)] coincide with

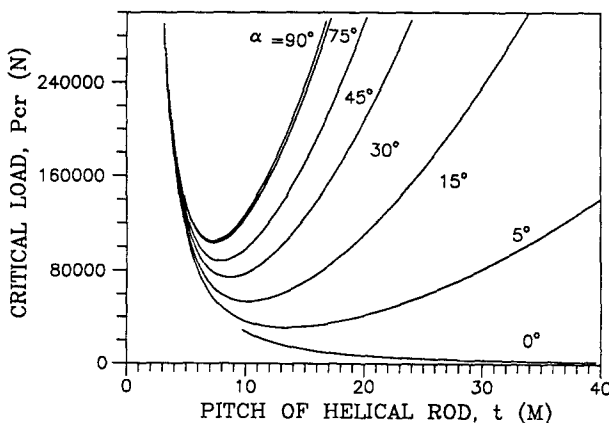

Fig. 4. The effect of hole inclination on the buckling load.

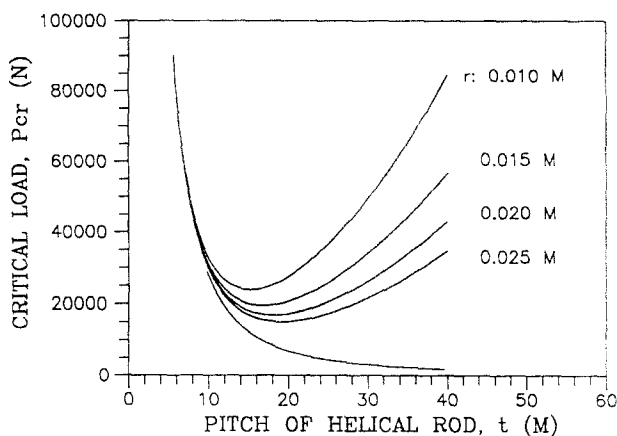

Fig. 5. The effect of clearance on the buckling load.

the points of intersection of the set of curves in Fig. 4 with the equilibrium curve [equation (16)] for continuous buckling. For small values of the angle α (where the drill hole is nearly vertical), these points of intersection correspond to large values of t_0 and small values of P_0 .

From eqn (19) for continuous buckling, the symbolic load P and buckling pitch t are not affected by the hole inclination angle. However, the applied force F [eqn (17)] required to produce the same buckling on the string increases when α increases, which is to compensate the part of the axial load reduced due to the change in the string inclination (weight component along the hole axis).

In summary, the buckling load in transition buckling in highly inclined holes is more sensitive to the hole inclination change. Since the transition buckling loads in this situation is much larger in magnitude compared to that in continuous buckling, the form of continuous buckling will dominate. However, in nearly vertical holes, transition buckling is more likely to occur.

6.3. Effect of hole clearance (helix radius r)

The critical load P_{cr} for transition buckling [eqn (19)] is plotted as a function of the helix pitch t for several hole clearances ($r = 0.01$ – 0.025 m for an inclination of $\alpha = 15^\circ$) in Fig. 5. In these plots, the numerical values of the other parameters in eqn (19) have the same values as those given in Section 6.2. It can be seen from this figure that for any given pitch t , the buckling load increases with decreasing hole clearance. A smaller hole clearance is therefore preferable if a string is to withstand larger buckling loads.

For the case of continuous buckling, the hole clearance r does not influence the buckling load or the helix pitch.

6.4. Effect of string density and stiffness

It can be seen from eqn (16) for continuous buckling that given a constant applied axial force at the top end, the string buckling increases with increasing string density q . On the other hand, if a constant load is to be maintained at the lower end, as is required in some case of drilling, for which the lower buckling load can be readily expressed as

$$W = F + qL \cos \alpha$$

or from eqn (17),

$$P = W - \frac{1}{2}qL \cos \alpha. \quad (25)$$

By applying eqn (25) into eqn (16) and assuming a constant W , we can easily see that larger

q causes less buckling to the string. A similar conclusion will be arrived at for the form of transition buckling.

As the string stiffness EI increases, the applied forces both for continuous buckling [eqn (16)] and for transition buckling [eqn (19)] increases to produce the same string buckling. So large stiffness will reduce the string buckling significantly.

7. COMPARISON OF OUR RESULTS OBTAINED WITH THOSE IN EARLIER WORK

7.1. Weightless string

Lubinski *et al.* (1962) considered the behaviour of a weightless string in the process of “continuous buckling”. Our expression for the load–pitch relation [eqn (16)] is identical to that obtained by Lubinski *et al.* (1962) and Cheatham and Pattilo (1984) when we equate q to zero in the equation. The processes of unconstrained buckling considered by Gere and Timoshenko (1990) and unloading considered by Cheatham and Pattilo (1984) are equivalent to our case of transition buckling [eqn (19)], in which the string is not or no longer constrained by the hole wall. The load–pitch relations also coincide when we assume the same condition $q = 0$. Their results can be taken as a special case, i.e. $q = 0$ in our solution.

The buckling load–pitch relation obtained by Paslay and Bogy (1964) for the drill string in a state of unstable equilibrium in the case of weightless string may be written

$$F_{cr} = \frac{(1-\nu)^2}{(1+\nu)(1-2\nu)} \frac{\pi^2 EI n^2}{L^2}. \quad (26)$$

For the special case in which Poisson’s ratio $\nu = 1/3$, this becomes identical to our expression (19) (with $q = 0$) for the critical buckling load in transition (unstable) buckling.

7.2. String of weight

Explicit results given in others work are available in several special situations and are cited below for comparison.

Horizontal hole. In the horizontal hole ($\alpha = 90^\circ$), the critical buckling load obtained from Paslay and Bogy’s model when the drill string is in a state of unstable equilibrium is given by

$$F_{cr} = \frac{\pi^2 EI}{t^2} + \frac{q(1-\nu)t^2}{\pi^2 r}. \quad (27)$$

This is identical in form to our expression (19) (with $\alpha = 90^\circ$) again for the case of transition buckling, but the former predicts a smaller buckling load due to the factor $(1-\nu)$ in the second term.

Vertical hole. Mitchell (1988) and Kwon (1988) obtained the buckling force–pitch formula for the continuous buckling and varying helix pitch, which is written below as

$$F_{cr}(z) = \frac{2\pi^2 EI}{t(z)^2}. \quad (28)$$

It takes a similar form to that from Lubinski *et al.* (1962) but with F_{cr} equating to the axial load at the calculated point on the string. For a long string in suspension, that is, the lower part in compression and the upper part in tension, the buckling helix pitch is calculated by

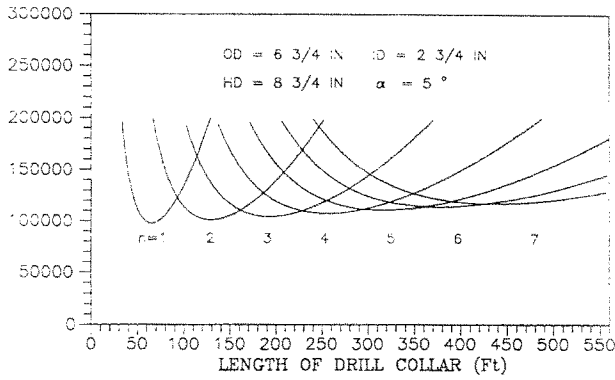

Fig. 6. Critical bit load versus the length of drill string (our helical model).

$$qZ = \frac{2\pi^2 EI}{t(Z)^2} \tag{29}$$

where Z is measured from the neutral point where axial force is zero down to the point under consideration. The difference between their formula [eqn (28)] and ours [eqn (16)] lies in the estimation of buckling force. The buckling load in eqn (29) varies along the string and hence results in a monotonous decrease in the pitch t as Z increases, while the buckling load on the left side of eqn (16) is constant, which is equal to the axial load at the middle point. Consequently, a constant pitch is achieved as is assumed in Section 2.

Inclined hole. The results from our formula [eqn (19)] and from Paslay and Bogy (1964) are shown in Figs 6 and 7 respectively for comparison. In these figures the buckling loads W at the lower (bit) end were plotted against the string length L at different buckling mode number n . Substituting eqn (25) into (19), we have the load W plotted against L shown in Fig. 6. The following numerical values were used for the parameters to obtain the curves in the two figures,

$$E = 3 \times 10^7 \text{ psi} \quad r = 1 \text{ in.}$$

$$I = 99.2 \text{ in}^4 \quad \alpha = 5$$

$$q = 8.55 \text{ lb in}^{-1} \quad \nu = 0.3.$$

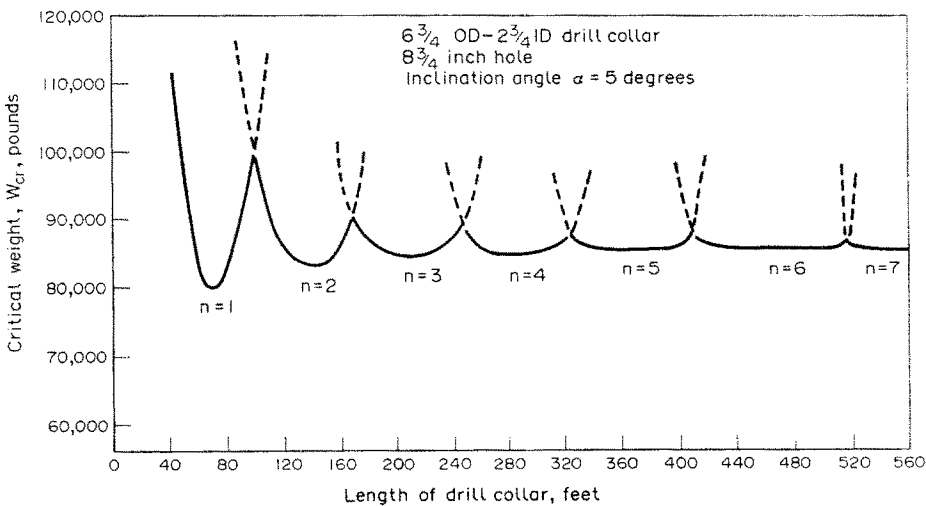

Fig. 7. Critical bit load versus the length of drill string (Paslay and Bogy's finite Fourier series model).

It can be seen that the plots obtained in Figs 6 and 7 are similar and the critical bit weights obtained from our helical model are larger.

Dellinger *et al.* (1983) used an empirical formula for the minimum applied critical buckling load, F_{cr} . This was derived directly from experimental results obtained by Lubinski *et al.* (1962):

$$F_{cr} = 2.93 (EI)^{0.479} q^{0.522} \left(\frac{\sin \alpha}{r} \right)^{0.436} \tag{30}$$

Another formula from Dawson and Paslay (1984)

$$F_{cr} = 2 \left(\frac{EIq \sin \alpha}{r} \right)^{1/2} \tag{31}$$

was modified from Paslay and Bogy's (1964) buckling criterion for horizontal holes and was designated for the case of inclined holes. Equation (31) denotes the minimum buckling force with respect to a specific pitch for the transition buckling. It is worth noticing that both the formulae [eqns (30) and (31)] are not concerned with the total string weight.

Our minimum critical buckling force for transition buckling from eqns (17) and (20) is written again

$$F_{cr} = 2 \left(\frac{EIq \sin \alpha}{r} \right)^{1/2} - \frac{1}{2} qL \cos \alpha. \tag{32}$$

The buckling force F_{cr} in eqns (30)–(32) has been plotted as a function of hole inclination α in Fig. 8 [curves (1)–(5)] respectively. The last three curves (3)–(5) correspond to the results from eqn (32) for different string lengths, namely $L = 50, 100, 150$ m respectively. The numerical values selected for the other relevant parameters are the same as those given in Section 6.2.

Figure 8 indicates that general trend of variation is observed for eqns (30)–(32). Our eqn (32) predict the smallest buckling force F_{cr} at the upper end and the empirical formula [eqn (30)] provides the largest buckling force. Dawson's formula [eqn (31)] can be considered as a special case of our eqn (32) at $L = 0$. Compared with the other two buckling formulae, our formula predicts a more reasonable buckling force depending on the total string weight (total length). The longer the string length is, the smaller the applied buckling force will be.

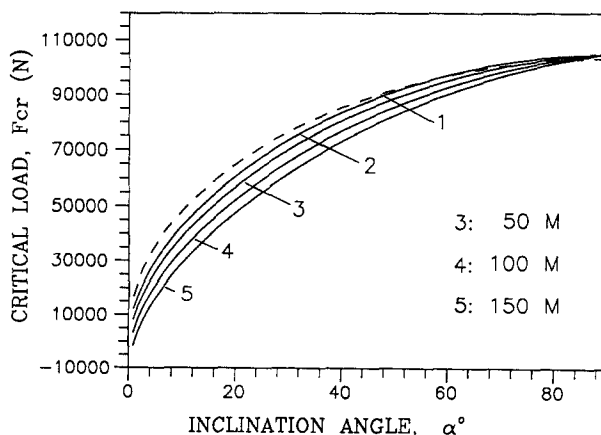

Fig. 8. Comparison of helical buckling models.

8. DISCUSSION

In the present paper, the equilibrium of a uniform drill and/or tubing string buckled under gravity and applied compressive forces, and confined within an inclined cylindrical hole of constant larger radius has been considered. Our assumptions regarding the geometry of the buckled drill string (so long as contact with the drill hole wall is maintained) follows that adopted by some of the earlier authors (Lubinski, 1962; Cheatham, 1984). Thus, we suppose that under the action of compressive forces, the string will deform into a helix of constant radius. We have shown in Section 5.1 that this configuration corresponds to one of stable equilibrium where the string has deformed into a helix whose pitch ι and also the buckling mode number vary continuously with the applied axial thrust P as the axial thrust is varied. We have also considered the interesting case, not previously studied, that as the applied axial thrust P exceeds a critical value, the drill string can assume an unstable equilibrium configuration (see Section 5.2) in which contact with the hole wall is lost. It was suggested that an unstable configuration of this type is necessarily assumed when the drill string geometry undergoes a sudden (finite) change in passing from one stable equilibrium configuration to another.

In Section 7.1, we have shown that the result of Lubinski *et al.* (1962) and Cheatham and Pattilo (1984) was for weightless string and considered only the effect of the applied load. It is a special case of our general solutions [eqns (16) and (19)]. The inclusion of string weight will give a smaller helix pitch since the string weight also contributes to the buckling.

As has been mentioned in the introduction to the present paper, Paslay and Bogy's work (1964) is interesting because the assumed buckled equilibrium configuration of the string differs from that assumed by both ourselves and most other authors. It was supposed that the buckled configuration of the string was given by the expression

$$\gamma = \sum_{i=1}^N a_i \sin \frac{i\pi z}{L} \quad (33)$$

where a_i s are constants to be determined by solving a system of equations derived by the energy method. Thus, in eqn (33) the angular coordinates γ of any point on the buckled string was supposed to be a periodic function (finite Fourier series) of the height of the point, z , above the string base. The string was subjected to the action of both gravitational and applied axial forces. Closed form buckling load–pitch relations are readily obtained from Paslay and Bogy's work in only a number of special cases. Comparison between our results and those of Paslay and Bogy (1964) in several typical cases, that is, weightless, horizontal and inclined strings [see eqns (19), (25), (26) and Figs 6, 7] indicates that our critical loads are larger than those predicted by Paslay and Bogy (1964). This follows as a result of different assumptions for the buckled string configuration (Timoshenko, 1986). However, these two assumed initial string equilibrium configurations do not induce a significant difference in the magnitudes of the critical buckling loads.

Dawson simplified Paslay and Bogy's critical buckling formula for strings in inclined holes and assumed infinite string length. The buckling force equation (31) was obtained by calculations similar for deriving eqns (20) and (21). So it specifies the minimum buckling force at some pitch [similar to eqn (21)]. Equation (31) takes a similar form to our eqn (32) (except the last term). Since it does not consider the total weight (length) of the string, it will give a larger applied buckling force for the same buckling mode or pitch [eqn (31)]. In addition, it seems that there was a calculation error in the equation that a factor $(\frac{2}{3})^{1.2}$ (≈ 1.22) on the right side of eqn (31) was missing [see eqn (33) in Paslay and Bogy's work and eqn (A1) in Dawson's], which means the formula will give an even larger F_{cr} (1984). Therefore, the buckling force predicted by Dawson's formula [eqn (31) after correction] is the largest compared with eqns (32), (30) and Paslay and Bogy's results (1964). So Dawson's simplification of Paslay and Bogy's formula for inclined holes overestimated the buckling force. The empirical formula [eqn (30)] gives the second largest buckling force. This might be explained by the fact that, in actual string buckling, resistance will be encountered in hole wall–string contact, thus a larger force would be needed. It also has to be noticed

that eqns (30) and (32) are applicable to non-vertical strings in transition buckling. For continuous buckling, eqns (16) and (28) should be used. Which form the string buckling will take is dependent on the concrete buckling load as has been concluded in Section 5.3.

We have also concluded in Section 5.3 that in the vertical situation, the transition buckling [eqn (19)] appears to be the dominant form of buckling. However, it can be expected that in a real string buckling situation, this process can only occur on a few occasions of specific confining and loading condition, because the wall-string friction might resist the free jump of the string from the hole wall. Therefore, the continuous buckling [eqn (16)] will, in general, govern the buckling process.

It is also noted that our assumption of a constant helix pitch is an approximation. In reality of string buckling, a variable pitch along the string is more reasonable. This was adopted in Mitchell and Kwon's analysis. For the special case of vertical holes, the formulae obtained by Mitchell [eqn (28)] considered a changing load along the string from zero to qL (total string weight below neutral point) and our solution [eqn (16)] takes a constant load equating to the average load at the middle point ($\frac{1}{2}qL$, half the string weight below neutral point) along the entire string. Comparing them quantitatively, we find that provided the same applied buckling force and/or string weight, the helical pitch calculated from our formula [eqn (16)] will be smaller for $0 < Z < L/2$, exact at $Z = L/2$ and larger for $Z > L/2$. So our solution emphasizes the average effect of the axial load on the string buckling configuration and is proper for describing the buckling configuration of low buckling mode. However, by assuming the simplified buckling configuration, we obtained the concise and explicit analytical solution to the string buckling in general inclination situations. Whereas under the varying pitch assumption, an exact and explicit solution was arrived at only for the vertical situation. For other inclination cases, numerical methods must be used. These are tedious and time consuming. Certainly, our general solution is gained by losing some accuracy in characterizing the local buckling configuration. Here, we attempt to minimize this error by modifying the buckling formula [eqn (16)] according to the relations of these two models [eqns (16) and (29)] for the case of vertical hole. Assuming that in inclined holes, these two solutions have the same relation at the middle point, then our buckling force and pitch are equal approximately to those from the differential equation by numerical method (Mitchell, 1988). Therefore we obtain the changing pitch along the buckled string from our modified formula

$$F + qZ \cos \alpha = \frac{2\pi^2 EI}{l(Z)^2} \quad (34)$$

for any inclined strings, where Z is measured from the neutral point downwards.

In the above, a buckling formula for varying pitch configuration is obtained explicitly by considering the features of our solution [eqn (16)] in relation to the explicit solution [eqn (28) of the differential equation, Mitchell (1988)] available only in a special case. This approximate eqn (34) coincides with eqn (29) exactly in the vertical situation and thus is believed to be of acceptable accuracy in inclined holes. It simplifies greatly the buckling analysis for inclined strings in continuous buckling and is meaningful for the tubing design and analysis of drill string situations.

It has to be mentioned that the wall-string friction is not dealt with in our analysis, which will naturally cause some errors in describing the string postbuckling configuration. The problem studied in the present paper is also idealized in the sense that the treatment of the string buckling as a static problem. However our work presented in the present paper disclosed a useful estimation of postbuckling configuration and some interesting characteristics of the helical buckling process. It reveals the effects of the general string and hole parameters on string buckling, which provide hints for the measures to combat the string buckling. All these stimulate further study on helical string buckling in cylindrical holes.

9. CONCLUSIONS

(1) Explicit and general solutions for the helical buckling of tubing and drill strings using energy method are obtained.

(2) The buckling analysis has led to two forms of buckling in which the transition buckling can occur for some specific cases and the continuous buckling will in general dominate the buckling process.

(3) An approximation is proposed for continuous buckling formula, which provides an explicit formula for string buckling with varying helix pitch in any inclination position.

(4) The buckling forces for inclined strings in transition buckling predicted by our model are smaller than those by the earlier formulae introduced by Dawson and Paslay (1984) and Dellinger *et al.* (1984). The total string weight (length) is considered in our calculation.

Acknowledgements—Financial support given by the Lulea University of Technology and by the NUTEK (National Swedish Board for Technical Development under grant 1990: 157) for this work is gratefully acknowledged. The authors would also like to thank Professor B. Johansson for valuable discussions.

REFERENCES

- Cheatham, J. B. and Pattilo, P. D. (1984). Helical postbuckling configuration of a weightless column under the action of an axial load. *Soc. Pet. Engng JI* **24**, 467–472.
- Dawson, R. and Paslay, P. A. (1984). Drillpipe buckling in inclined holes. *J. Pet. Technol.* **36**, 1734–1738.
- Dellinger, T. B., Gravey, W. and Walraven, J. E. (1983). Preventing buckling in drill strength. U.S. Patent No. 4,384,483.
- Gere, J. M. and Timoshenko, S. P. (1990). *Mechanics of Materials*. PWS-KENT, Boston.
- Kwon, Y. W. (1988). Analysis of helical buckling. *SPE Drilling Engng.* **3**, 211–216.
- Landau, L. D. and Lifshitz, E. M. (1970). *Theory of Elasticity*. Pergamon Press, Oxford, London.
- Langhaar, H. L. (1962). *Energy Methods in Applied Mechanics*. Wiley, New York.
- Lubinski, A., Althouse, W. S. and Logan, J. L. (1962). Helical buckling of tubing sealed in packers. *J. Pet. Technol.* **14**, 665–670; *Trans., AIME*, 225.
- Mitchell, R. F. (1988). New concepts for helical buckling. *SPE Drill. Engng* **3**, 303–310.
- Paslay, P. A. and Bogy, D. B. (1964). The stability of a circular rod laterally constrained to be in contact with an inclined circular cylinder. *J. Appl. Mech.* **31**, 605–610.

APPENDIX

A1. Configuration geometry of the buckled drill rod

The position vector of the representative point (x, y, z) (Fig. 1) on the helix is given by

$$\mathbf{r}(s) = \mathbf{i}_x r \cos \gamma + \mathbf{i}_y r \sin \gamma + \mathbf{i}_z \frac{\gamma l}{\pi} \quad (\text{A1})$$

and the unit tangent vector of the helix at this point is given by:

$$\begin{aligned} \hat{\mathbf{T}} &= \left(-\mathbf{i}_x r \sin \gamma + \mathbf{i}_y r \cos \gamma + \mathbf{i}_z \frac{l}{\pi} \right) \frac{d\gamma}{ds} \\ &= \mathbf{i}_x \cos \phi \sin \gamma + \mathbf{i}_y \cos \phi \cos \gamma + \mathbf{i}_z \sin \phi \end{aligned} \quad (\text{A2})$$

where, s = the arc length of the helix and is measured from the lower end [see also Fig. 1(b)].

Then

$$\hat{\mathbf{T}} \cdot \frac{d\hat{\mathbf{T}}}{ds} = 0 \quad (\text{A3})$$

and so

$$\frac{d\hat{\mathbf{T}}}{ds} = k\hat{\mathbf{N}} \quad (\text{A4})$$

where $\hat{\mathbf{N}}$ denotes the principle normal to the helix and the scalar

$$k = \frac{1}{R} = \left| \frac{d\hat{\mathbf{T}}}{ds} \right| \quad (\text{A5})$$

denotes the curvature of the helix. Also,

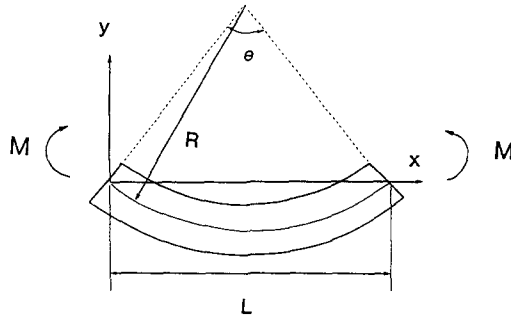

Fig. A1. Deformation of a drill string under the action of bending moments.

$$\begin{aligned} \frac{d\hat{\mathbf{T}}}{ds} &= (-\cos \phi \cos \gamma, -\cos \phi \sin \gamma, 0) \frac{dy}{ds} \\ &= -(\cos \gamma, \sin \gamma, 0) \frac{\cos^2 \phi}{r}. \end{aligned} \tag{A6}$$

We then have for the curvature radius of the helix

$$R = \frac{1}{k} = r \sec^2 \phi. \tag{A7}$$

A2. Strain energy stored in the buckled string due to bending

From Fig. A1, the bending moment M which must be applied to a uniform string to bend it into a curve of constant radius of curvature R is given by

$$M = \int_A \sigma_{xx} y \, dA = \int_A E \varepsilon_{xx} y \, dA \tag{A8}$$

where A denotes the cross-sectional area of the string and y is the distance of the point of separation of the force $\sigma_{xx} \, dA$ from the buckled axis of the string. Also from Fig. A1

$$\varepsilon_x = \frac{(R+y) \, d\theta - R \, d\theta}{R \, d\theta} = \frac{y}{R} \tag{A9}$$

and so

$$M = \frac{E}{R} \int_A y^2 \, dA = \frac{EI}{R} \tag{A10}$$

where E and I are the Young's modulus and radius of gyration respectively of the string (also assumed constant). The strain energy stored in the string is $1/2 \, \sigma_{ij} \varepsilon_{ij}$ per unit volume. The strain energy stored in the string due to bending is therefore given by

$$U_b = \frac{1}{2} \int \sigma \varepsilon (L \, dA) = \frac{1}{2} \int \sigma \frac{y}{R} L \, dA = \frac{EIL}{2R^2}. \tag{A11}$$